

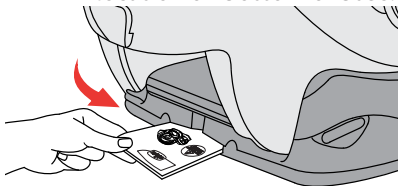

fit2™

Car Seat User Guide

For future use, STORE USER GUIDE
in location on bottom of base.



IS0144.2E

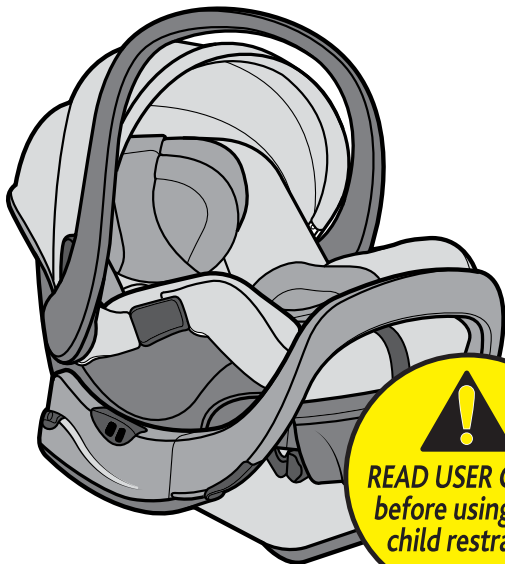

**READ USER GUIDE
before using this
child restraint.**

©2016 Artsana USA, Inc.
www.chiccousa.com

If you have any problems with your Chicco Child Restraint,
or any questions regarding installation or use, please call:

Chicco Customer Service
1-877-424-4226

Please have Model and Serial Number available when you call.
These are located on a label on the bottom of the Child Restraint.

For future reference, fill in the information below. The information can be found on the label
on the bottom of the Child Restraint.

Model Number: _____

Serial Number: _____

Manufactured In: _____

TABLE OF CONTENTS

Registration	2
Child Guidelines	4
Safe Use Checklist	6
Important Warnings	8
Best Practices	14
Need Help?	15

VEHICLE INFORMATION

Vehicle Seating Positions	16
Vehicle Seat Belts	18
What is LATCH?	20

CHILD RESTRAINT OVERVIEW

Child Restraint Components	22
Base Stage 1 & 2	26

BASE INSTALLATION

Install with Base Setup	30
Install Using LATCH	32
Install Using LAP-SHOULDER BELT	38
Install Using LAP BELT ONLY	44
Install Carrier to Base	48

WITHOUT BASE INSTALLATION

Install without Base Setup	52
Install Using LAP-SHOULDER BELT	54
Install Using Shoulder Belt Guide	58
Install Using LAP BELT ONLY	62

SECURING YOUR CHILD

Securing Child with Harness	66
Secure Child Checklist	74

ADDITIONAL INFORMATION

Base Release Handle	76
LATCH Storage	77
Newborn Positioner	78
Head Rest Insert	80
Handle Positions	81
Adjusting Crotch Strap	82
Canopy	84
Installation on an Aircraft	85
Cleaning and Maintenance	86

REGISTRATION

Please complete the Registration Card that came with your Child Restraint and mail it promptly.

Child Restraints could be recalled for safety reasons. You must register this restraint to be reached in a recall. Send your name, address, e-mail address if available, and the restraint's model number and manufacturing date to:

Artsana USA, Inc.
1826 William Penn Way
Lancaster, PA 17601
or call 1-877-424-4226

or register online at <http://www.chiccousa.com/carseatregistration.aspx>

For recall information, call the U.S. Government's Vehicle Safety Hotline at 1-888-327-4236 (TTY: 1-800-424-9153), or go to <http://www.NHTSA.gov>.

REGISTRATION

PAGE INTENTIONALLY LEFT BLANK

CHILD GUIDELINES

This Child Restraint is designed for children ages Birth to at least 2 years old. **ONLY** use this Child Restraint if the child meets **BOTH** of the following Weight and Height requirements:

- **Weight is between 4 and 35 pounds (2 and 16 kg).**
- **Height is 35 inches (89 cm) or less and child's head is no less than 1" below the top of the head rest.**

Base Stage 2 is ONLY for children who are able to crawl or walk.

The Newborn Positioner is only for infants who weigh between 4 and 11 pounds (2 and 5 kg). See Newborn Positioner on page 78.

⚠ For premature infants, you must consult the infant's doctor before using this Child Restraint. A premature infant may have difficulty breathing or have other medical problems when placed in a seated position.

CHILD GUIDELINES

⚠ WARNING! Use of this Child Restraint is **ONLY** for children who meet **ALL** of the requirements shown here. If the child is not within these requirements, select a different car seat (such as a convertible car seat).

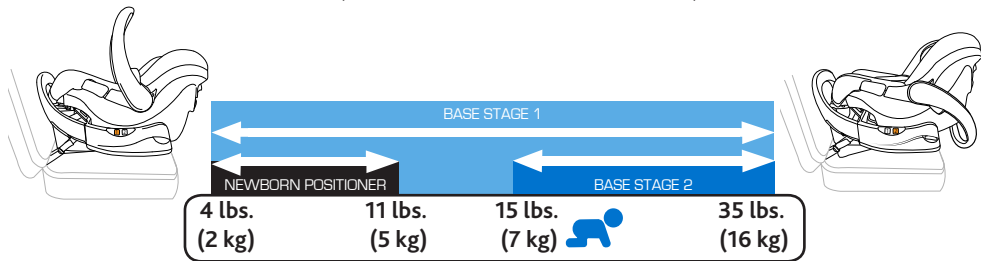

- Chicco and the American Academy of Pediatrics recommend all children ride **REAR-FACING** until age 2 or they reach the weight/height limits of this seat.
- **NEVER** turn this Child Restraint FORWARD-FACING.

SAFE USE CHECKLIST

⚠️ YOUR CHILD'S SAFETY DEPENDS ON YOU! You **MUST** follow the detailed instructions in this User Guide to ensure the steps below are performed correctly!

- Make sure your child meets the age, weight, and height requirements:**
Refer to the "Child Guidelines" section on page 4.
- If using Base, select the correct Base Stage for your child's developmental milestones, age, weight and height:**
Refer to the "Base Stage 1" requirements section on page 26.
Refer to the "Base Stage 2" requirements section on page 28.
- Select a safe seating location in your car:**
Refer to the "Vehicle Seating Positions" section on page 16 and 17.
- Install Base or Carrier Rear-Facing ONLY:**
Refer to the "Child Guidelines" section on page 4.



SAFE USE CHECKLIST

- Ensure that the Child Restraint is properly leveled when installed:**

- Check Child Restraint for a snug fit in your car:**
While holding Child Restraint near belt path used, pull side to side and forward. Belt should remain tight and Child Restraint should not move more than 1" (25 mm) from vehicle seat back or side-to-side.

- Secure your child:**
Refer to the "Securing Child with Harness" section on page 66.

IMPORTANT WARNINGS



FAILURE TO FOLLOW THESE INSTRUCTIONS AND THE PRODUCT LABELS CAN RESULT IN SERIOUS INJURY OR DEATH TO YOUR CHILD.

Take Time to Read This User Guide

- Carefully read and understand all instructions and warnings in this User Guide. Your child's safety depends on you knowing how to setup, install and use this Child Restraint properly.
- Before installing this Child Restraint in a vehicle, be sure to also check the vehicle owner's manual for information on proper installation.
- **NEVER** allow others to use this Child Restraint until they have read and understood all instructions in this User Guide.

Make Sure Child Fits This Child Restraint

- Use only with children who weigh between 4 and 35 lbs (2 kg to 16 kg) and whose height is 35 inches (89 cm) or less.
- **Do Not** use this child restraint if top of child's head is within 1 inch of the top of the headrest.
- Only use the NEWBORN POSITIONER provided for infants who weigh between 4 and 11 lbs (2 and 5 kg).

IMPORTANT WARNINGS

WARNING

DEATH or SERIOUS INJURY CAN OCCUR

Secure Child Properly

- Snugly adjust the belts provided with this child restraint around your child. A loose harness could cause the child to be ejected in a sharp turn, sudden stop or crash, resulting in serious injury or death.

A snug strap should not allow any slack. It lies in a relatively straight line without sagging. It does not press on the child's flesh or push the child's body into an unnatural position.

- **NEVER** use clothing or blankets that interfere with fastening or tightening the harness. An unsecured child could be ejected in a sharp turn, sudden stop or crash!

To keep child warm, place a blanket over child and restraint **AFTER** you have properly secured child in harness.

- **ALWAYS** check to make sure buckle is securely latched. If buckle separates, child could be killed or seriously injured.
- **NEVER** leave child unattended. Do not allow children to play in or around the Child Restraint.
- **ALWAYS** keep child properly secured in harness whenever child is in carrier.

IMPORTANT WARNINGS

! WARNING

DEATH or SERIOUS INJURY CAN OCCUR

Install Child Restraint Correctly

- **NEVER PLACE THIS CHILD RESTRAINT IN VEHICLE SEATING LOCATION WITH A FRONTAL AIR BAG, UNLESS THE AIR BAG CAN BE TURNED OFF.** If the airbag inflates, it can cause serious injury or death to your child. For vehicles with side air bags, refer to your vehicle owners manual for information on your child restraint installation.
- **ALWAYS** install this Child Restraint in a back seat if possible.



According to accident statistics, children are safer when properly restrained in the rear seating positions rather than in the front seat.

- **NEVER** install in a rear facing, side facing or on the back of a folded down vehicle seat.
- **ALWAYS** secure this Child Restraint with the vehicle's child restraint anchorage system (LATCH) if available OR with a vehicle seat belt.
- **ALWAYS** install rear-facing when using this Child Restraint in a vehicle. Your child could be killed or seriously injured if you install this restraint forward-facing.

IMPORTANT WARNINGS

WARNING

DEATH or SERIOUS INJURY CAN OCCUR

Install Child Restraint Correctly

- **BEFORE** each use, **ALWAYS** check to make sure restraint is tightly secured in the vehicle seat.
- **NEVER** use Child Restraint in a vehicle seating position where it cannot be secured tightly. A loosely installed child restraint will not protect your child in a crash.
- **Never leave carrier or base unsecured in your vehicle even when it is unoccupied.** It could injure other occupants in a sharp turn, sudden stop or crash.
- **DO NOT** install this child restraint using an inflatable seat belt. The interaction of the inflatable portion of the vehicle's belt with this child restraint **can result in serious injury or death.** Install using LATCH instead, or move the car seat to a position with a suitable seat belt type.
- To **prevent ejection or breathing difficulties, proper recline is required.** When installing the Child Restraint, check the bubble level on the base. Refer to pages 26-28 to make sure your child meets the requirements for Stage 1 or Stage 2.
- Make sure nothing interferes with carrier attachment to base. **ALWAYS** check attachment.
- **ONLY** use Chicco Fit 2 infant carriers with Fit 2 bases.
- **DO NOT** use Chicco Fit 2 infant carriers with Chicco KeyFit/KeyFit 30 bases.

IMPORTANT WARNINGS



Ensure Child's Safety When Using Child Restraint

- **NEVER** leave child unattended.
- **SUFFOCATION HAZARD:** Infant carrier can roll over on soft surfaces and suffocate child. **NEVER** place carrier on beds, sofas or other soft surfaces.
- **STRANGULATION HAZARD:** Children have **STRANGLED** in loose or partially buckled harness straps. Fully restrain the child even when carrier is used outside the vehicle.
- **Fall Hazard:** Child's activity can move carrier. **NEVER** place carrier on counter tops, tables, or any other elevated surface.
- Do not use the infant carrier if it is damaged or broken.
- **BE SURE** handle is locked in the "carry position" before lifting carrier by handle. An unlocked handle could move unexpectedly, causing injury to child.
- **NEVER** place carrier in top of shopping cart. Carrier will not be secure and could fall causing injury to child.
- **ALWAYS** check buckle and other parts for hot surfaces. A hot surface could burn child! Cover unoccupied carrier with blanket when leaving in a vehicle exposed to sunlight or high temperatures.



Check Condition of Restraint

- **DO NOT** use if the Harness or LATCH straps are cut, frayed or damaged.
- **DO NOT use this Child Restraint if it is more than 6 years old.** Check manufacturer's label on underside of Child Restraint for the "Do Not Use After" date.
- **DO NOT use any accessories, pads or products not included with this Child Restraint, unless approved by Chicco USA.** Doing so will void the warranty of this Child Restraint.
- You **MUST** replace this Child Restraint if it has been involved in a crash, even if you cannot see visible damage. A damaged Child Restraint may not protect your child in a future crash.
- **Do not modify your Child Restraint.**
- For proper removal and installation of the harness straps contact Chicco USA for additional instructions.
- **Do not use Child Restraint if any component is damaged, broken, or missing parts.**
Call 1-877-424-4226 to find out if the damaged part or parts can be replaced.

BEST PRACTICES

- Ensure all vehicle occupants are properly restrained before traveling. Unrestrained occupants can be thrown around and may be seriously injured or seriously injure other occupants in a sharp turn, sudden stop or crash.
- Do not leave loose objects, such as books, bags, etc., in the back of the vehicle. In the event of a sharp turn, sudden stop, or crash, loose objects can be thrown around and possibly cause serious injury to vehicle occupants.
- Cover the Child Restraint when the vehicle is parked in sunlight. Parts of a Child Restraint can become very hot if left in the sun. Contact with these parts can burn a child's skin. Always check the surface of any metal or plastic parts before putting your child in the Child Restraint.
- To avoid strangulation, Do not allow children to play with vehicle seat belts. If possible, move unused belts out of reach.
- Do not use anything to raise the Child Restraint off the vehicle seat. In a sharp turn, sudden stop, or crash, the Child Restraint could slide and potentially cause serious injury.
- Never use a second-hand Child Restraint with an unknown history.
- Never use any accessories that are not included with this child restraint, unless specifically approved by Chicco. For more information, go to www.chiccousa.com/accessories.

Need Help Securing Your Child Restraint?

The following sources are available to help ensure your Child Restraint is properly installed:

- Contact Chicco USA by visiting our website at www.chiccousa.com or calling our Customer Service 1-877-424-4226. Please have Model and Serial Number available when you call. These are located on a label on the bottom of the Child Restraint.
- Refer to your vehicle manual for Child Restraint installation tips.
- Contact a certified Child Passenger Safety Technician in your area by visiting safercar.gov and select "Find Local Child Seat Help" or call 1-866-SEAT CHECK (1-866-732-8243) or visit seatcheck.org.

VEHICLE SEATING POSITIONS



▲ WARNING! NEVER PLACE THIS CHILD RESTRAINT IN A VEHICLE SEATING LOCATION WITH A FRONTAL AIR BAG, UNLESS THE AIR BAG CAN BE TURNED OFF.

The back seat is the safest place for children 12 and under. See your vehicle owner's manual for Child Restraint installation and instructions.

VEHICLE SEATING POSITIONS

Some vehicles have no seating positions which are compatible with this Child Restraint. If in doubt, contact the vehicle manufacturer for assistance. Only forward-facing vehicle seats can be used with this Child Restraint.



Make sure no more than 4 inches of the Child Restraint base is past the edge of the vehicle seat.

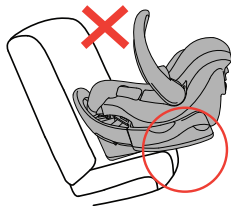

Do not use on a folded down vehicle seat back.



VEHICLE SEAT BELTS

The information in this section only applies to installation with vehicle seat belts.

For simplest installation use LATCH

Vehicle seat belts differ from vehicle to vehicle. Refer to your vehicle owner's manual for specific information about seat belts and their use with Child Restraints.

Shoulder belt with switchable retractor:

Putting the shoulder belt in the locked/switched mode as the last step is optional. The shoulder belt Lock-Off replaces the need for the locked/switched mode. Using the locked/switched mode may cause Child Restraint to tilt.

VEHICLE SEAT BELTS

The following types of vehicle belts **MUST NOT** be used to install this Child Restraint. If any of the belt types listed below are in the chosen seating position, choose another vehicle seating position or use LATCH if available.

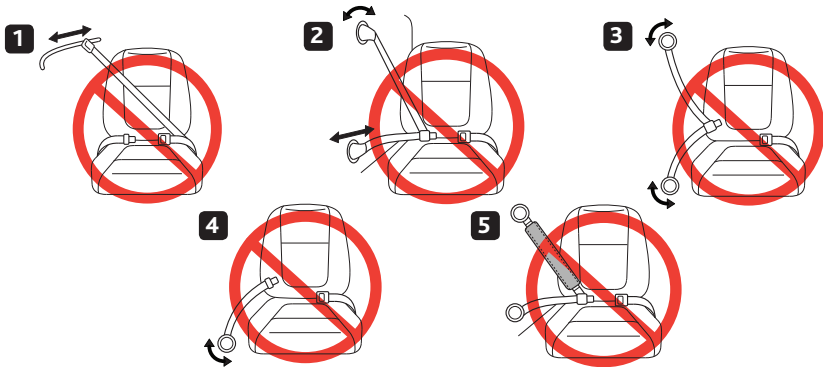

1. Motorized (automatic) vehicle belts.
2. Door mounted vehicle belts.
3. Lap-shoulder Belts with 2 retractors (unless Lap Belt has a "Lock Mode").
4. Non-Locking (ELR) Lap Belts.
5. Inflatable seat belts.

WHAT IS LATCH

⚠ WARNING: This Child Restraint is designed to be used with lower LATCH anchors at the standard spacing (11 inches) **ONLY!** Refer to vehicle owner's manual for information about LATCH and Child Restraint installation positions.

LATCH = Lower Anchors and Tethers for Children

United States Motor Vehicle Safety Standards have defined a system for installing Child Restraints in vehicles called LATCH. **LATCH may ONLY be used IN PLACE OF vehicle belt if the vehicle is equipped with LATCH anchor points. DO NOT use both the seat belt and LATCH at the same time. Please refer to the vehicle owner's manual for designated LATCH locations in vehicles.**

LATCH in the vehicle consists of a top tether anchor point, which is not used with this child restraint, and two lower anchor points. Some vehicles owner's manual use the term "**ISOFIX**". **LATCH** can also be used in vehicle seating positions equipped with **ISOFIX**.

If the vehicle is equipped with **LATCH**, the vehicle lower anchor points may be visible at the seat crease. If not visible, the seating position may be marked with a symbol (fig. a) or a colored dot.

WHAT IS LATCH

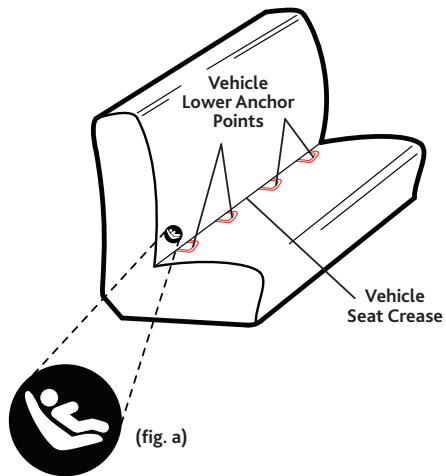

CARRIER COMPONENTS

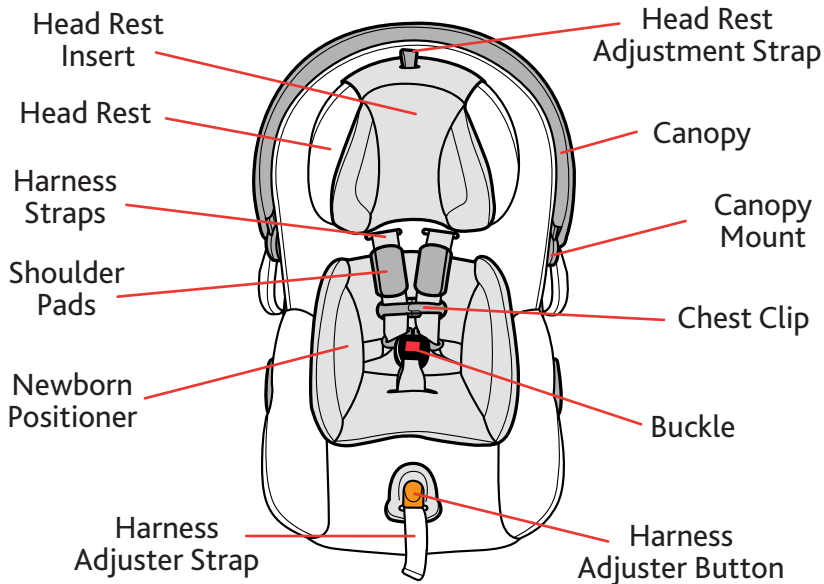

CARRIER COMPONENTS

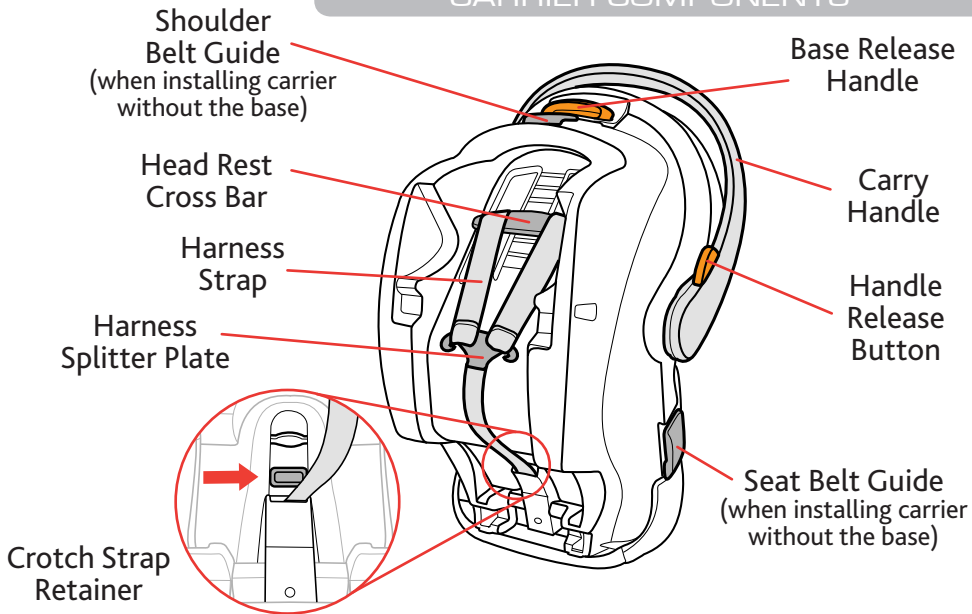

BASE AND LATCH COMPONENTS

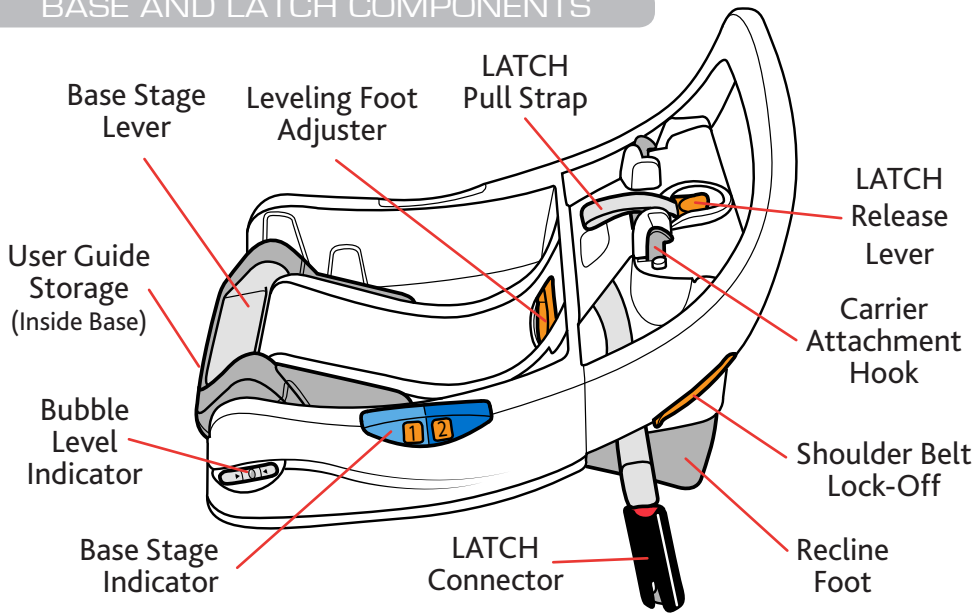

PAGE INTENTIONALLY LEFT BLANK

BASE STAGE 1

Choose the Stage that best fits your child: *Stage 1* allows for a **more reclined** install and riding position for a child that meets the weight and height requirement for this restraint.

BASE STAGE: **1**
4 – 35 lbs (2 – 16 kg)

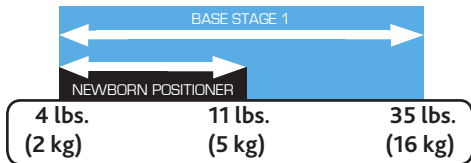

Use with children:

- Who weigh between 4 and 35 lbs (2 – 16 kg).
- And height is less than 35 inches (89 cm).
- And top of head is at least 1 inch below top of Head Rest.
- When Harness Straps can be positioned at or just below the child's shoulders*.



See Harness Height Adjustment on page 68.

BASE STAGE 1

To install this Child Restraint in Stage 1, rotate the Base Stage Lever over into Stage 1 on the Base. The Base Stage Indicator '1' icon will turn orange.

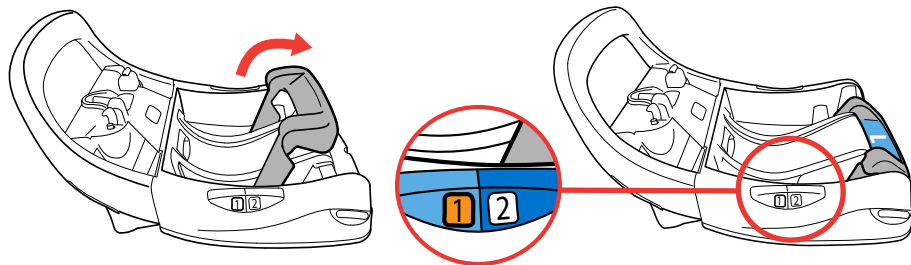

Install Child Restraint:

- Base installation continued on page 30

BASE STAGE 2

Choose the Stage that best fits your child: *Stage 2* is an *upright install* for a child that meets the developmental requirement for this restraint. This allows for *more leg room* and a more upright riding position for your child.

BASE STAGE: **2**
15 – 35 lbs (7 – 16 kg)

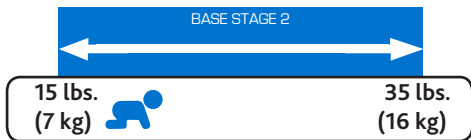

Use with children:

- Who are able to **crawl or walk**.
- Who are between 9-24 months of age.
- Who weigh between 15 and 35 lbs (7 –16 kg).
- And height is less than 35 inches (89 cm).
- And top of head is at least 1 inch below top of Head Rest.
- When Harness Straps can be positioned at or just below the child's shoulders*.



See Harness Height Adjustment on page 68.

BASE STAGE 2

⚠ Infants may have difficulties breathing in a more upright seating position. **ONLY** use base Stage 2 with children that can crawl or walk. Approximately 9 months old.

To install this Child Restraint in Stage 2, rotate the Base Stage Lever over into Stage 2 on the Base. The Base Stage Indicator '2' icon will turn orange.

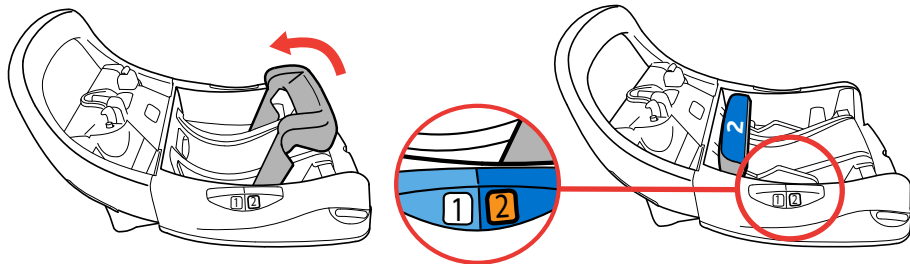

Install Child Restraint:

- Base installation continued on page 30

INSTALL WITH BASE SETUP

⚠️ Infants may have difficulty breathing when in a sitting position. Make sure the seat is reclined properly so that your child's head does not fall forward. **Failure to properly recline the Child Restraint could increase the child's risk of serious injury or death.**

1



See page 16 for "Vehicle Seating Positions" before installing. Make sure the vehicle is on a level surface. Place Base on selected vehicle seat. Make sure it is not blocking the vehicle seat belt buckle.

2

Set Base Stage Lever to the correct Stage, depending on your child. See pages 26-29 for more information **(2a)**. Locate the Bubble Level Indicator and adjust the seat recline by pulling up on the center Leveling Foot Adjuster until the Bubble falls between the arrows on the Bubble Level Indicator **(2b)**.

Installation Options:

- *LATCH installation continued on page 32*
- *Lap-Shoulder Belt installation continued on page 38*
- *Lap Belt Only installation continued on page 44*

INSTALL WITH BASE SETUP

2b

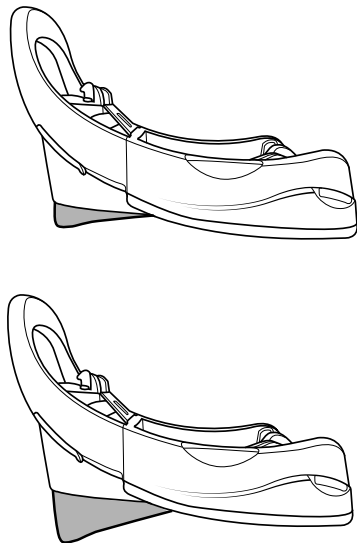
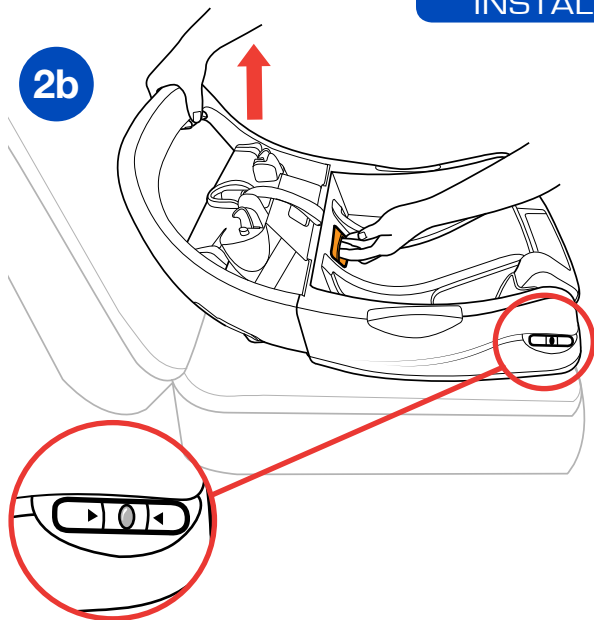

INSTALL USING LATCH

⚠ Store LATCH Connectors properly in the compartments when not using for installation - See page 77.

⚠ When installing with LATCH, the unused seat belt should not be buckled behind the Child Restraint System as this will engage the inflatable portion of the belt.

- 1 Pull up on the LATCH Release Lever and loosen LATCH straps to their full length.
- 2 Locate the LATCH Connector storage compartments. Remove both LATCH Connectors.

INSTALL USING LATCH

1

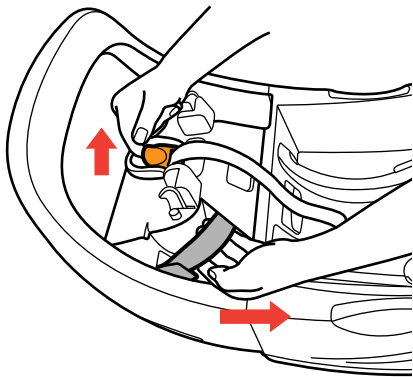

2

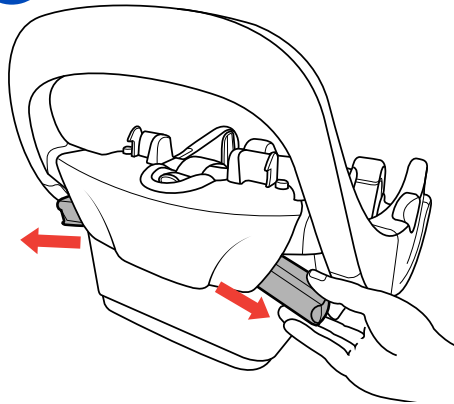

INSTALL USING LATCH

- 3 Locate the LATCH anchor bars in your vehicle. Attach both LATCH Connectors to the vehicle LATCH anchor bars.
- 4 Tighten LATCH straps by pulling up on LATCH Pull Strap while pressing Base firmly into vehicle seat.

INSTALL USING LATCH

3

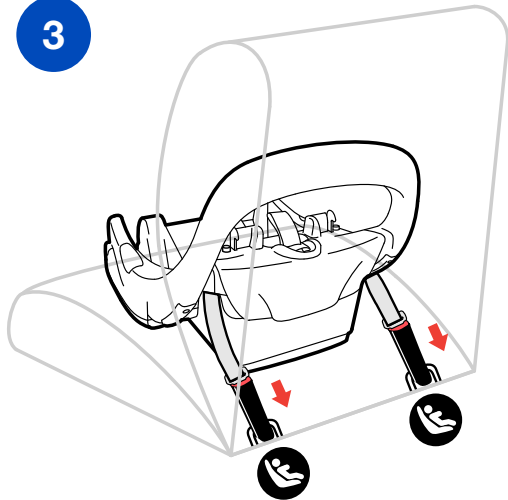

4

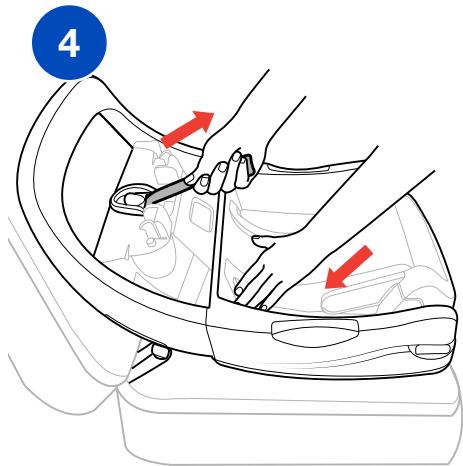

INSTALL USING LATCH

- 5 Roll LATCH Release Strap and store in Release Strap Storage Compartment.

CHECK YOUR WORK

- ✓ Hold Base at each side and pull side to side and forward. Base should not move more than 1" (25 mm) from vehicle seat back or side-to-side.
- ✓ Check installation before every use!

Install Child Restraint:

- *Installation continued on page 48*

INSTALL USING LATCH

5

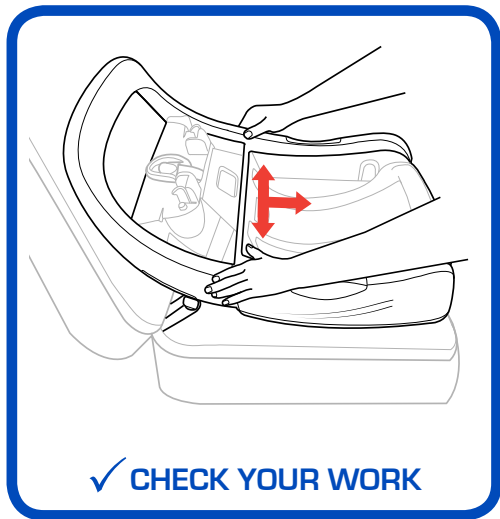
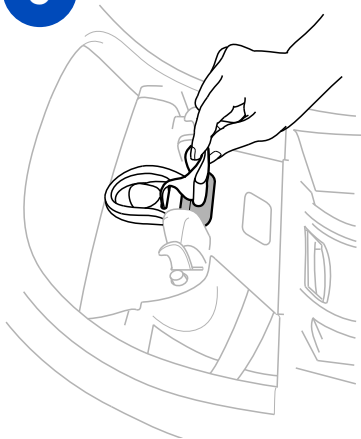

✓ CHECK YOUR WORK

INSTALL USING LAP-SHOULDER BELT

- 1 Thread vehicle seat belt up through the belt path on the side of the Base.
- 2 Pull vehicle seat belt down through the vehicle seat belt path on opposite side of the Base. Buckle the vehicle seat belt.

INSTALL USING LAP-SHOULDER BELT

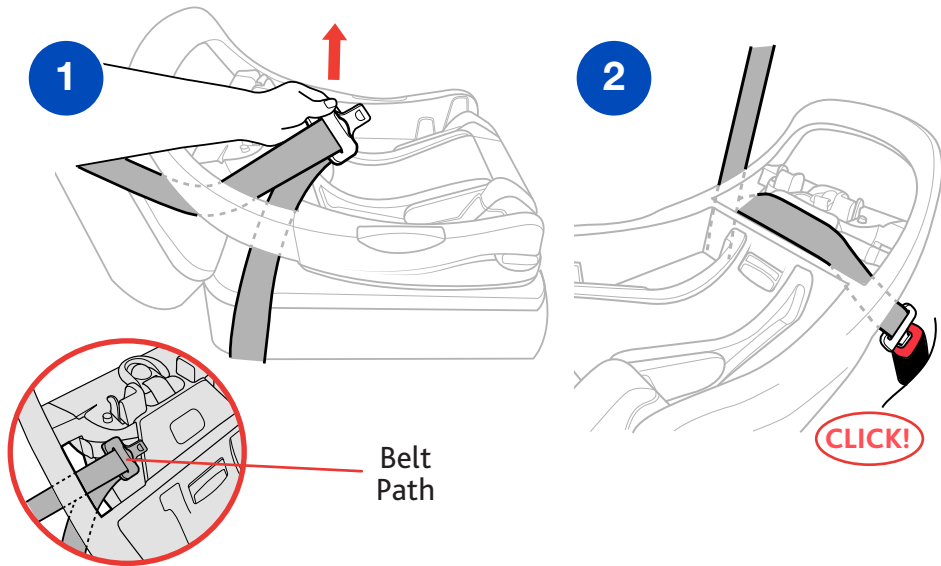

INSTALL USING LAP-SHOULDER BELT

- 3 While pushing down on the Base, pull up on the vehicle shoulder belt to remove all slack from the vehicle lap belt.

INSTALL USING LAP-SHOULDER BELT

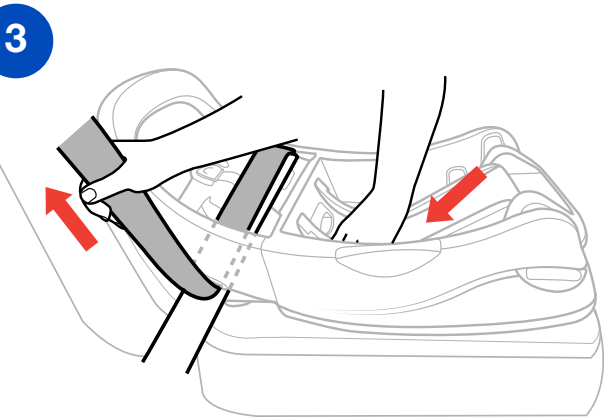

INSTALL USING LAP-SHOULDER BELT

- 4 While holding the shoulder belt tight, slide the shoulder belt strap firmly into Shoulder Belt Lock-Off. Always use the Lock-Off on the opposite side of where the vehicle seat belt is buckled.

⚠ Do **NOT** pull on shoulder belt after it is positioned in Lock-Off. This could damage the Lock-Off and/or the vehicle belt

CHECK YOUR WORK

- ✓ Hold Base at each side and pull side to side and forward. Base should not move more than 1" (25 mm) from vehicle seat back or side-to-side.
- ✓ Check installation before every use!

Install Child Restraint:

• *Installation continued on page 48*

INSTALL USING LAP-SHOULDER BELT

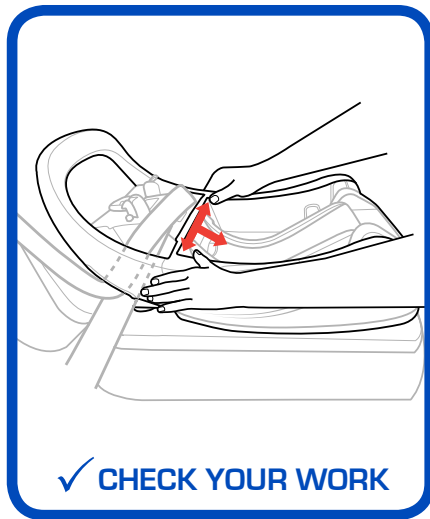
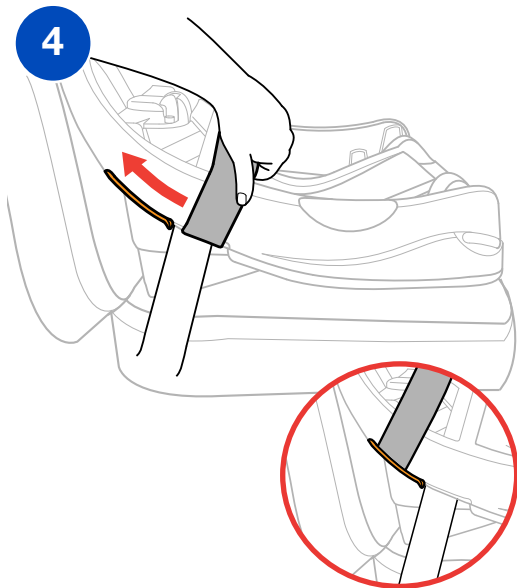

INSTALL USING LAP BELT ONLY

- 1 Thread vehicle seat belt up through the belt path on the side of the Base.
- 2 Pull vehicle seat belt down through the vehicle seat belt path on opposite side of the Base. Buckle the vehicle seat belt.

INSTALL USING LAP BELT ONLY

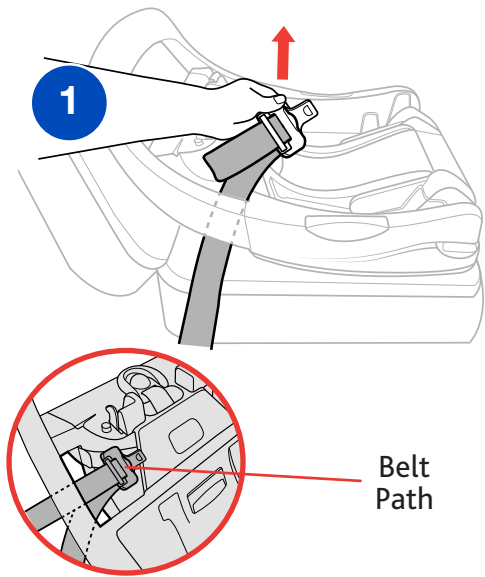

INSTALL USING LAP BELT ONLY

- 3 While pushing down on the Base, pull up on the loose end of the vehicle lap belt to remove all slack.

CHECK YOUR WORK

- ✓ Hold Base at each side and pull side to side and forward. Base should not move more than 1" (25 mm) from vehicle seat back or side-to-side.
- ✓ Check installation before every use!

Install Child Restraint:

- *Installation continued on page 48*

INSTALL USING LAP BELT ONLY

3

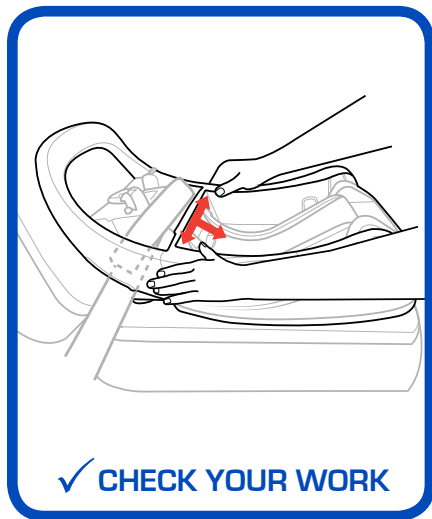
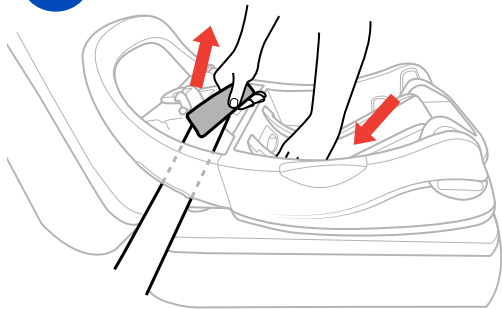

INSTALL CARRIER TO BASE

IMPORTANT: Before installing Child Restraint refer to page 26-29 to determine the best Base Stage for your child.

- 1 Insert the Carrier into the Base.
- 2 Push down on the Carrier to make sure it locks onto the Carrier Attachment Hooks on the Base.

INSTALL CARRIER TO BASE

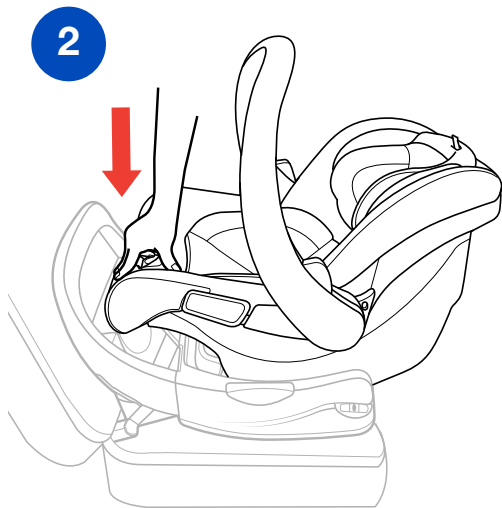
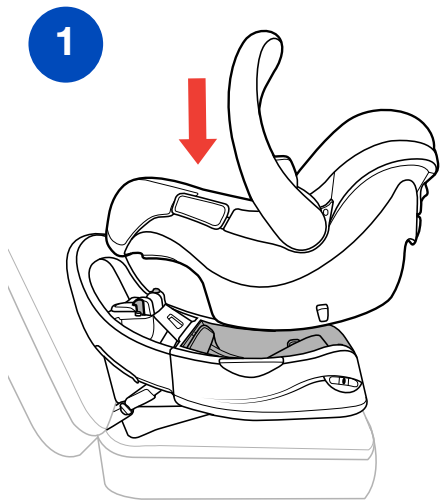

INSTALL CARRIER TO BASE

- 3 Check to make sure the Carrier is securely attached to the Base.
- 4 **STAGE 2 ONLY:** Rotate Carry Handle behind the Child Restraint when using Stage 2. It is recommended to leave the installed Base and Carrier in your vehicle when using Stage 2.

⚠ ALWAYS lift up on Carrier to verify it is properly attached to the Base.

CHECK YOUR WORK

- ✓ Hold Base at each side and pull side to side and forward. Child Restraint should not move more than 1" (25 mm) from vehicle seat back or side-to-side.
- ✓ Make sure Child Restraint is level by confirming that the bubble on the level indicator is between the level lines. Make sure infant's head does not fall forward. If necessary, re-adjust recline and repeat installation steps to make sure Child Restraint is installed properly.
- ✓ Check installation before every use!

INSTALL CARRIER TO BASE

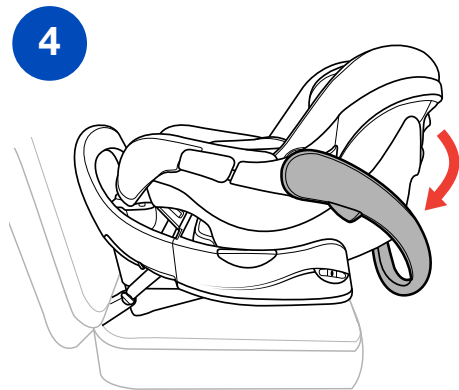
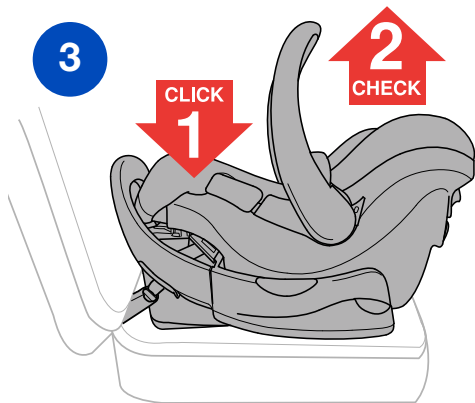

INSTALL **WITHOUT** BASE SETUP

⚠️ Infants may have difficulty breathing when in a sitting position. Make sure the seat is reclined properly so that your child's head does not fall forward. **Failure to properly recline the Child Restraint could increase the child's risk of serious injury or death.**

⚠️ **NEVER** install Child Restraint without Base using a non-locking vehicle belt. The installation will NOT be secure. Refer to your vehicle owner's manual for detailed vehicle belt information.

1



See page 16 for "Vehicle Seating Positions" before installing. Make sure the vehicle is on a level surface. Place Child Restraint on selected vehicle seat with child properly secured in Child Restraint (See *securing your child* on page 66). Make sure it is not blocking the vehicle seat belt buckle.

2

Position Child Restraint so that the Level Line (located on the seat label) is **LEVEL** with the ground.

3

If needed, use a rolled up towel to help level the Child Restraint properly.

Installation Options:

- *Lap-Shoulder Belt installation continued on page 54*
- *Lap Belt Only installation continued on page 62*

INSTALL **WITHOUT** BASE SETUP

2

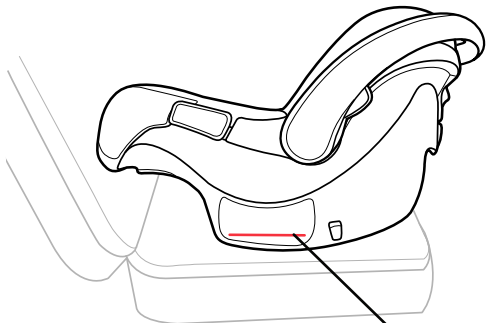

3

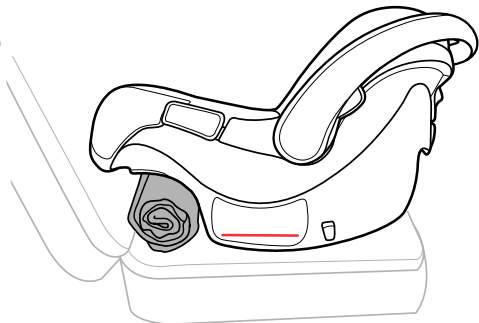

Level Line
(Seat Label)

INSTALL USING LAP-SHOULDER BELT

- 1 Thread vehicle seat belt up and slide into the Seat Belt Guide on the side of the Child Restraint.
- 2 Pull vehicle seat belt down and slide into the Seat Belt Guide on opposite side of the Child Restraint. Buckle the vehicle seat belt. Pull out all of the shoulder belt webbing and activate the locking mode of the vehicle belt. If belt does not lock, do not use that seating position to install the carrier.

INSTALL USING LAP-SHOULDER BELT

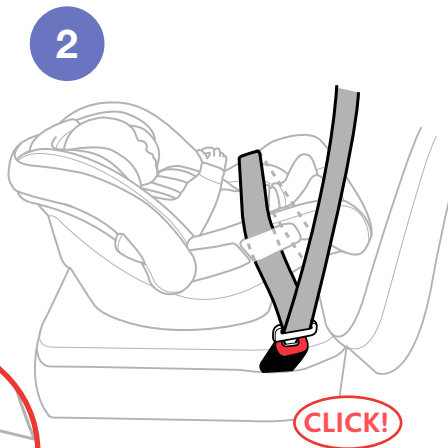
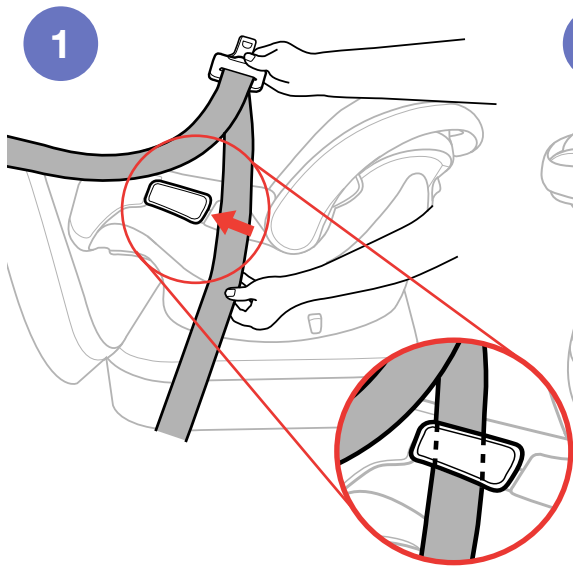

INSTALL USING LAP-SHOULDER BELT

Put the vehicle seat belt in the locked mode, see vehicle owner's manual for more information. A tightly rolled towel may be used under the front edge of the Carrier if needed to adjust the angle of the Carrier. Angle is correct when level line on Carrier is level with ground.

3

While pushing down on the Carrier, pull up on the vehicle shoulder belt to remove all slack from vehicle lap belt.

CHECK YOUR WORK

- ✓ Hold Child Restraint at each side and pull side to side and forward. Child Restraint should not move more than 1" (25 mm) from vehicle seat back or side-to-side.
- ✓ Make sure Child Restraint is level. Make sure infant's head does not fall forward. If necessary re-adjust recline and repeat installation steps to make sure Child Restraint is installed properly.
- ✓ Check installation before every use!

INSTALL USING LAP-SHOULDER BELT

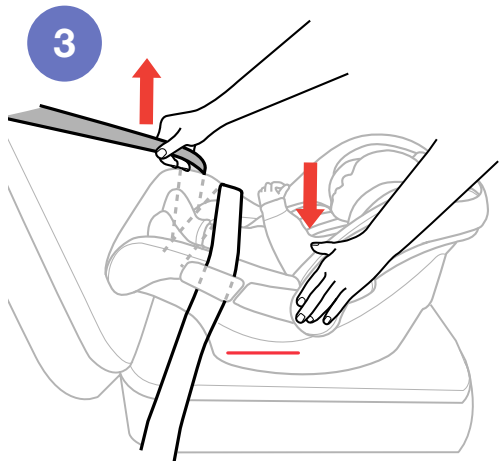

INSTALL USING SHOULDER BELT GUIDE

An optional Shoulder Belt Guide is on the back of the Child Restraint. The Guide offers additional stability when installing your Child Restraint without the Base using the Lap/Shoulder Belt. Make sure your vehicle seat belts have enough length to allow you to properly install the Child Restraint using the Shoulder Belt Guide.

- 4 With the Child Restraint placed and buckled without the Base and using the vehicle lap-shoulder belt in un-locked mode - pull the shoulder belt out and slide it around the back of the Child Restraint.
- 5 Thread the shoulder belt through the Shoulder Belt Guide. Then guide the shoulder belt around the carrier. Switch the shoulder belt into locked mode. Do not use this seating position if the vehicle belt does not lock.

INSTALL USING SHOULDER BELT GUIDE

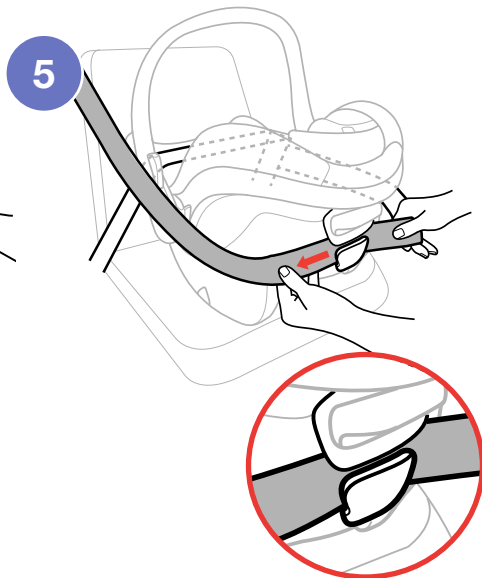
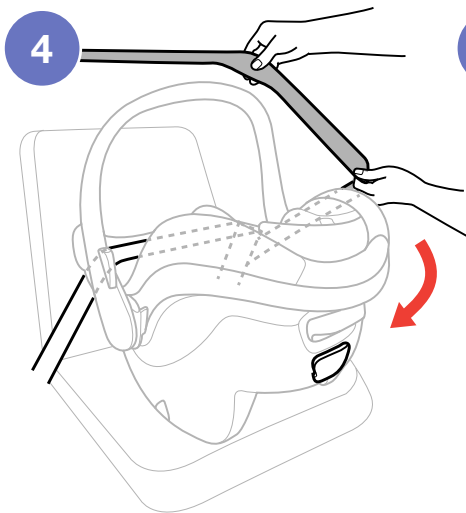

INSTALL USING SHOULDER BELT GUIDE

- 6 While pushing down on the Child Restraint, pull up on the vehicle shoulder belt to remove all slack from the vehicle lap and shoulder belt.

CHECK YOUR WORK

- ✓ Hold Child Restraint at each side and pull side to side and forward. Child Restraint should not move more than 1" (25 mm) from vehicle seat back or side-to-side.
- ✓ Make sure Child Restraint is level. Make sure infant's head does not fall forward. If necessary re-adjust recline and repeat installation steps to make sure Child Restraint is installed properly.
- ✓ Check installation before every use!

INSTALL USING SHOULDER BELT GUIDE

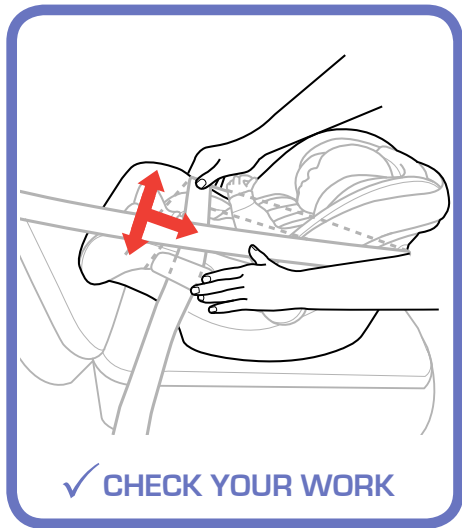
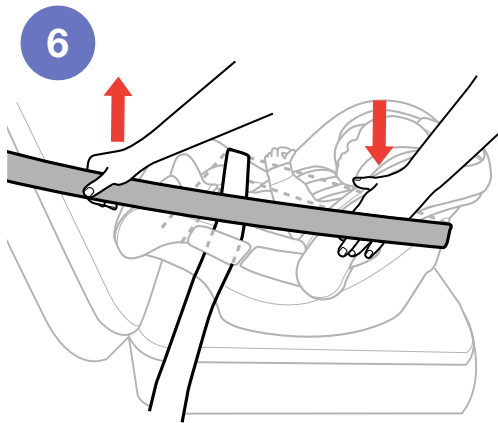

INSTALL USING LAP BELT ONLY

- 1 Thread vehicle seat belt up and slide into the Seat Belt Guide on the side of the Child Restraint.
- 2 Pull vehicle seat belt down and slide into the Seat Belt Guide on opposite side of the Child Restraint. Buckle the vehicle seat belt.

INSTALL USING LAP BELT ONLY

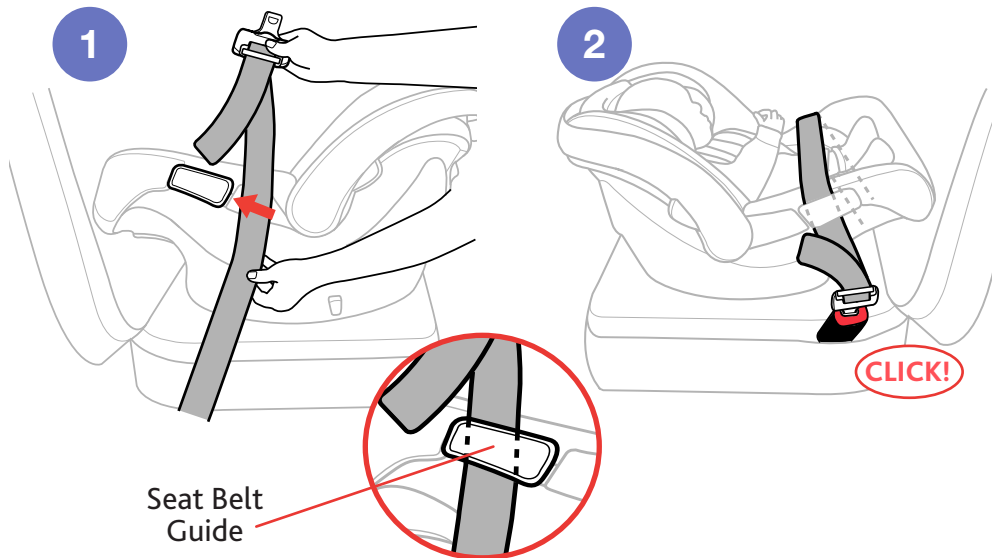

INSTALL USING LAP BELT ONLY

Put the vehicle seat belt in the locked mode, see vehicle owner's manual for more information. A tightly rolled towel may be used under the front edge of the Carrier if needed to adjust the angle of the Carrier. Angle is correct when level line on Carrier is level with ground.

3

While pushing down on the Child Restraint, pull up on the loose end of the vehicle lap belt to remove all slack.

CHECK YOUR WORK

- ✓ Hold Child Restraint at each side and pull side to side and forward. Child Restraint should not move more than 1" (25 mm) from vehicle seat back or side-to-side.
- ✓ Make sure Child Restraint is level. Make sure infant's head does not fall forward. If necessary re-adjust recline and repeat installation steps to make sure Child Restraint is installed properly.
- ✓ Check installation before every use!

INSTALL USING LAP BELT ONLY

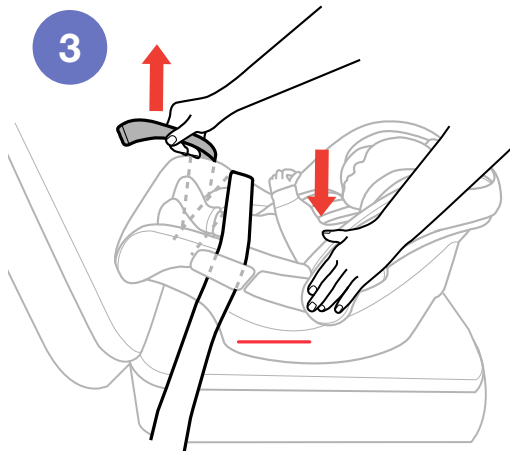

SECURING CHILD WITH HARNESS

For a better fit in the Carrier with smaller infants, the provided Newborn Positioner may be needed. See page 76 for more details.

- 1** Loosen harness by pressing the Adjuster Button and pulling out on both Harness Straps.
- 2** Press the button on the buckle and release both buckle tongues.
- 3** Separate chest clip and spread Harness Straps apart. Place child in carrier in seated position.

Child must be resting against back and bottom of carrier. Make sure child is not slouched.

SECURING CHILD WITH HARNESS

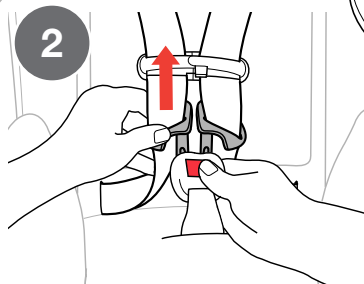
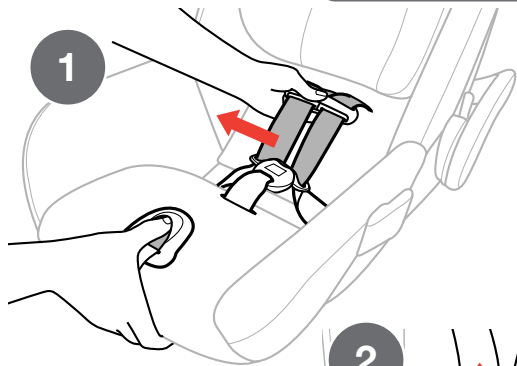

SECURING CHILD WITH HARNESS

- 4 Pull up on the Headrest Adjustment Strap and adjust the Head Rest up or down until the harness slots are AT or JUST BELOW top of child's shoulders. Pull up and push down on the Head Rest to make sure the Head Rest locks into position before tightening Harness.

⚠ NEVER use clothing or blankets that interfere with fastening or tightening the harness. An unsecured child could be ejected in a sharp turn, sudden stop or crash!

- 5 Pull Harness Straps over child's shoulders and pull waist straps around their waist.

Never secure child in Carrier with child dressed in bulky garments or heavy clothing. Heavy clothing can prevent harness from being properly tightened around child.

SECURING CHILD WITH HARNESS

4

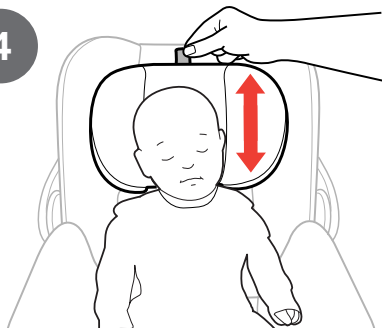

AT OR JUST BELOW

5

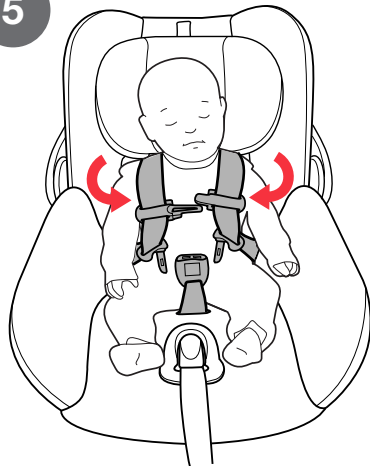

SECURING CHILD WITH HARNESS

- 6 Insert each Buckle Tongue into Harness Buckle; listen for a click **(6a)**. Pull up firmly on both Buckle Tongues to make sure that they are securely latched **(6b)**.
- 7 Fasten Chest Clip by snapping both sides together.

Harness Straps must be laying flat, free of twists and on top of child's shoulders.

SECURING CHILD WITH HARNESS

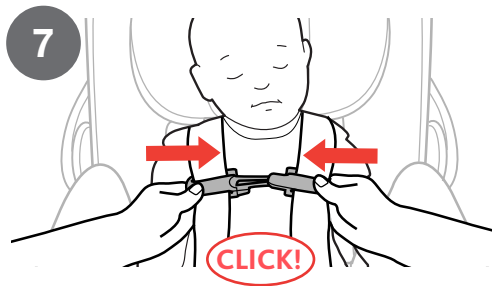
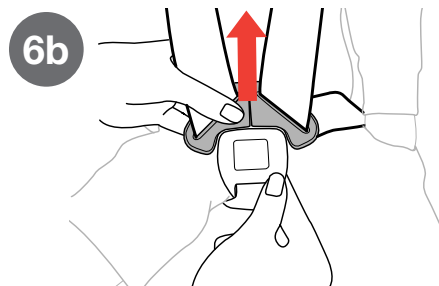
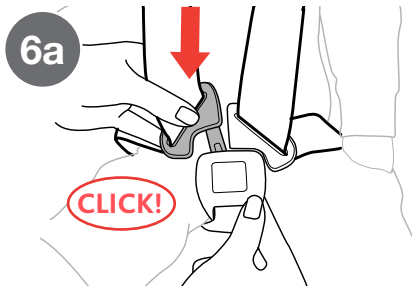

SECURING CHILD WITH HARNESS

Pull excess strap up through buckle tongues so that harness is snug around child's thighs.

- 8 Tighten the harness by pulling slowly on Harness Adjuster Strap while pulling up on both shoulder straps to remove all slack from below **(8a)**. Make sure the Harness Straps are snug on child. If you can pinch a fold in the Harness Strap at the child's shoulders, harness is too loose **(8b)**. If the Harness Straps are too loose pull the Harness Adjuster Strap more.
- 9 Move the Shoulder Pads up to the child's shoulders. Slide Chest Clip up to center of child's chest, level with the armpits.

⚠ WARNING - If harness is not snug around your child, child could be ejected in a sharp turn, sudden stop or crash resulting in serious injury or death.

SECURING CHILD WITH HARNESS

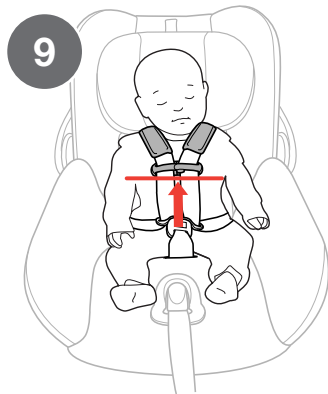
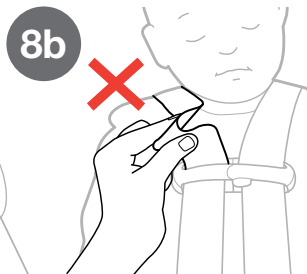
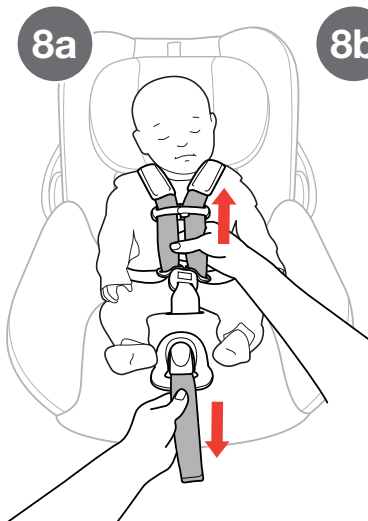

SECURING CHILD CHECKLIST

- ✓ **Harness Straps must be snug.** If you can pinch a fold in the strap at the shoulders, the harness is too loose. A snug strap should not allow any slack. It lies in a relatively straight line without sagging. It does not press on the child's flesh or push the child's body into an unnatural position.

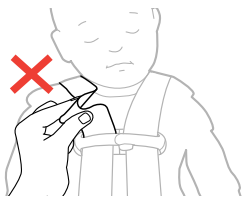

- ✓ **To ensure a better fit for smaller infants, the Newborn Positioner may be needed.** Never place extra padding under or behind the child. Only use the Newborn Positioner. Never use Newborn Positioner if child weighs more than 11 pounds.
- ✓ **Straps must lay flat, free of twists and centered on top of the child's shoulders.**
- ✓ **Check the height of the Harness Straps:** Position the Harness Straps at or just below the child's shoulders.



SECURING CHILD CHECKLIST

- ✓ Check the position of Chest Clip: Chest Clip should be centered on the child's chest, level with the armpits.
- ✓ Never secure child in Carrier with child dressed in bulky garments or heavy clothing. Heavy clothing can prevent harness from being properly tightened around child.
- ✓ Never secure child in Carrier with child wrapped in a blanket. To keep child warm, place a blanket over child AFTER you have properly secured and tightened harness around child.



NO Bulky Clothing

BASE RELEASE HANDLE

RELEASE CARRIER FROM BASE:

To unhook the Carrier from the Base, squeeze the Base Release Handle on the back of the Carrier then lift up on the Carry Handle.

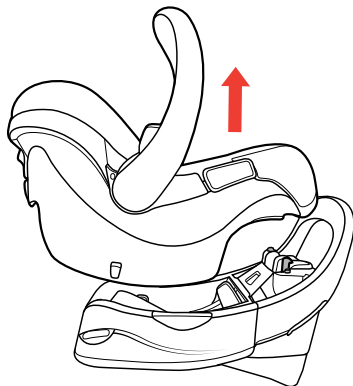
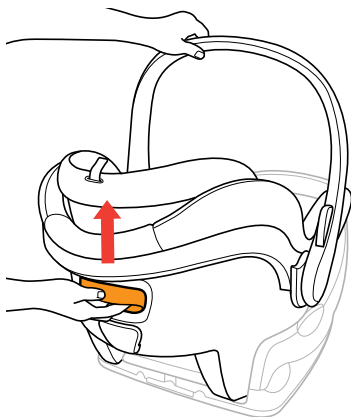

LATCH STORAGE

▲ Store LATCH Connectors properly in the compartments when not using for installation.

Store both LATCH Connector in compartments on either side of the Base when not in use.

- 1 Insert LATCH Connectors into the storage compartments.
- 2 Pull on the LATCH Pull Strap to secure LATCH Connectors in the compartments.
- 3 Roll LATCH Pull Strap and store in Pull Strap Storage Compartment.

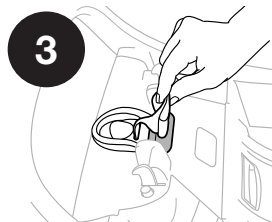
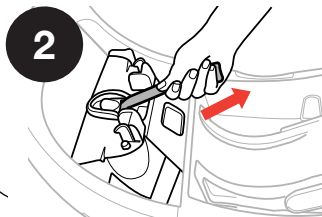
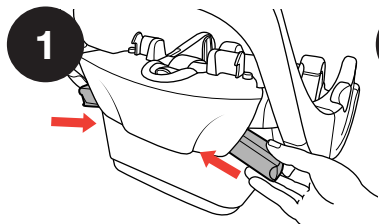

NEWBORN POSITIONER

⚠ WARNING - Use the NEWBORN POSITIONER provided for infants who weigh between 4 and 11 lbs (2 and 5 kg).

To ensure a better fit for smaller infants the Newborn Positioner may be needed. Do NOT use any other newborn positioner or pillows. Only use the one provided by Chicco for this Child Restraint.

- 1** Place the Newborn Positioner in the Carrier seat. Then pull the Buckle through slot in the bottom of Newborn Positioner.
- 2** Pull both Harness Straps over the side panels of Newborn Positioner.
- 3** Push Newborn Positioner firmly into Carrier to make sure it is properly positioned against the back of the seating area.

NEWBORN POSITIONER

1

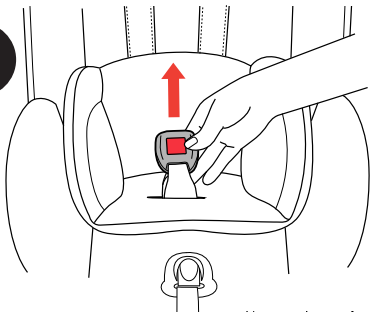

2

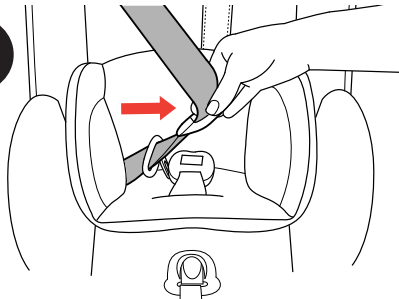

3

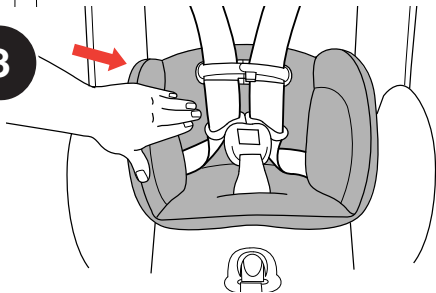

HEAD REST INSERT

To provide head support for smaller infants the Head Rest Insert may be used. The Head Rest Insert can be used with or without the Newborn Positioner.

- 1 To Install Head Rest Insert, thread the Head Rest Adjustment Strap through the button hole.
- 2 Slide the elastic straps around BOTH sides of the Head Rest.

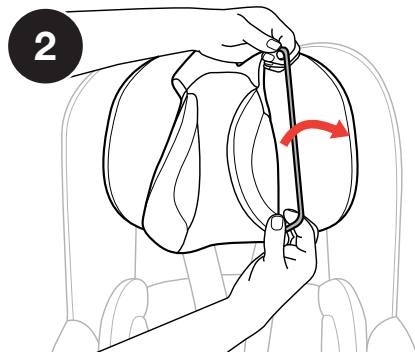
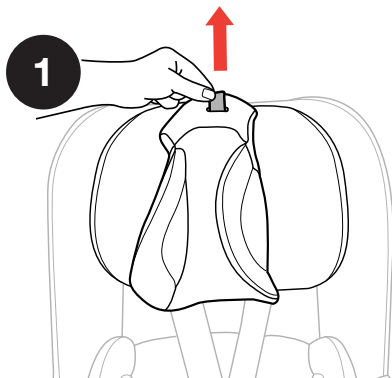

HANDLE POSITIONS

⚠ WARNING - NEVER adjust handle to Base Storage Position outside of the vehicle.

To Adjust Handle, press both of the Handle Release Buttons and rotate the handle. There are 4 positions:

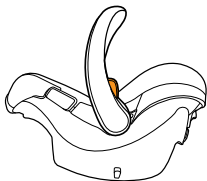

Carrying Position



Rocking Position

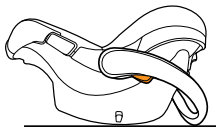

Stationary Position

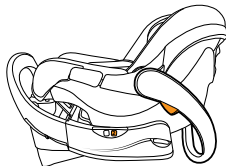

Base Storage Position - Can be used to maximize space in front of the child restraint when carrier and base are installed in the vehicle in either Stage 1 or Stage 2.

ADJUSTING CROTCH STRAP

Adjust Crotch Strap if strap is underneath child.

REMOVING CROTCH STRAP:

- 1** Flip the Carrier upside-down and locate the Crotch Strap Retainer. Turn Retainer slightly on underside of seat and insert corner through slot **(1a)**. Flip the Carrier upright and pull Crotch Strap up through the slot **(1b)**.

⚠ NEVER use Child Restraint without the Crotch Strap securely installed.

ADJUSTING CROTCH STRAP:

- 2** Reverse the removing instructions above to reinstall. There are two positions on the Carrier, as shown.
- 3** Make sure Crotch Strap Retainer lays flat against the bottom of the Child Restraint. Pull on Crotch Strap to make sure it is secure.

⚠ DO NOT USE Child Restraint if any part of the harness is damaged. For proper removal and installation of the harness straps visit the Chicco website at www.chiccousa.com or call 1-877-424-4226.

ADJUSTING CROTCH STRAP

1a

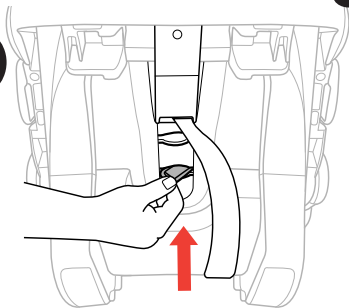

1b

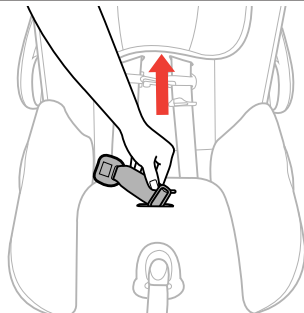

2

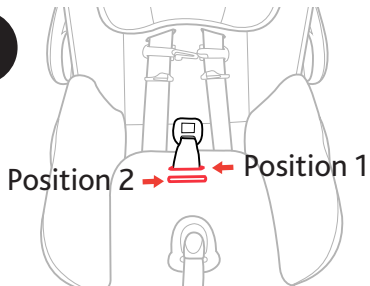

3

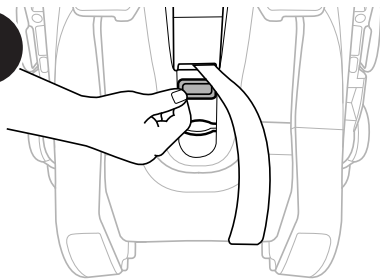

CANOPY

ADJUSTING CANOPY:

The Canopy can be adjusted by rotating the canopy forwards or backwards.

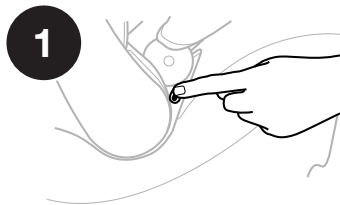
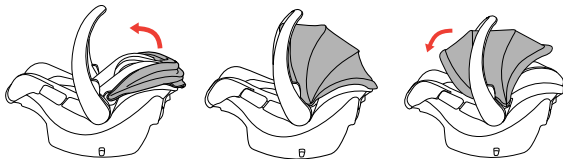
**REMOVING CANOPY:**

- 1 Press button on Canopy Mount and pull up to remove. Repeat for the other side.

ATTACHING CANOPY:

- 2 Insert both of the Canopy Mounts into the slots on the side of the Carrier. The Canopy Mounts will click into place.

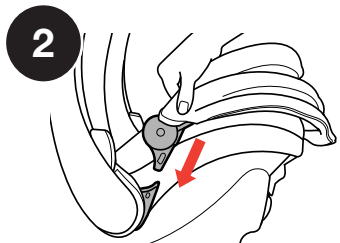

When traveling by airplane with your child, Chicco recommends taking the Carrier on the airplane with you so that you can use it with your child. Not only will it protect your child during take-off, landing, and turbulence, but also allow your child to be more comfortable.

- This Child Restraint is certified for use on aircraft. Contact the airline prior to travel to discuss their Child Restraint policy.
- Use this Child Restraint only on FORWARD-FACING aircraft seats.
- Install Carrier on an aircraft the same way it is installed in a vehicle when using a vehicle lap belt. Reference Without Base Installation Lap Belt ONLY on page 62.

CLEANING AND MAINTENANCE

⚠ DO NOT USE BLEACH, solvents or household cleaners as they may weaken plastics and straps.

⚠ DO NOT USE SOAPS OR LUBRICANTS on Buckle or LATCH hardware. It may cause them to malfunction.

- **Fabrics may be spot-cleaned, hand or machine washed:**
Hand wash using mild soap and water, or machine washed in cold water on delicate cycle using mild detergent. Hang to dry.

⚠ NEVER use Child Restraint without the seat pad.

For softgood removal instructions visit the Chicco website at www.chiccousa.com or call 1-877-424-4226.

- **Cleaning Shoulder Pads:**
Hand wash using mild soap and water. Hang to dry.
- **Cleaning Plastics:**
Sponge clean using warm water and mild soap. Towel dry.

CLEANING AND MAINTENANCE

- **Cleaning Harness:**

Sponge clean using warm water and mild soap. Air dry. **Do NOT machine wash.**

▲ DO NOT USE Child Restraint if any part of the harness is damaged. For proper removal and installation of the harness straps visit the Chicco website at www.chiccousa.com or call 1-877-424-4226.

- **Cleaning LATCH Straps:**

LATCH Straps cannot be replaced. Sponge clean using warm water and mild soap. Air dry.

- **Cleaning Buckle and LATCH Hardware:**

Sponge clean, using warm water and mild soap. If debris in buckle, remove and rinse in warm cup of water. Air dry. See page 82 for removal instructions.



Do NOT remove LATCH or Harness Adjuster Straps. For additional information visit the Chicco website at www.chiccousa.com or call 1-877-424-4226.

